

# Box USB

Référence produit : 90-60-538



## USER MANUAL & INSTALLATION INSTRUCTIONS

V2.1

**Contents**

- 1. PRESENTATION ..... 3
- 2. NMEA 0183..... 3
- 3. WIRED NMEA INPUT ..... 5
- 4. WIRED NMEA OUTPUT ..... 8
- 5. WIFI CONNECTION..... 10
- 6. USB CONNECTION..... 11
- 7. DATALOG..... 12
- 8. SETUP WITH A MULTIGRAPHIC ..... 12
- 9. INDICATORS ..... 14
- 10. USE OF THE "INIT" BUTTON..... 15
- 11. INSTALLATION ..... 17
- 12. FLOW CHART ..... 21
- 13. SET A WIFI CONNECTION WITH A SMARTPHONE ..... 22
- 14. THE APPLICATION "NKE DISPLAY PRO" ..... 24
- 15. TECHNICAL SPECIFICATIONS..... 25

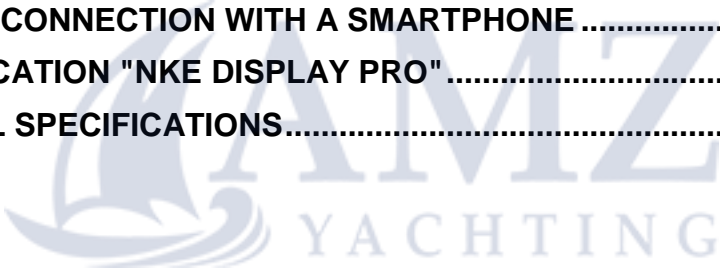

## 1. PRESENTATION

---

**nke USB BOX** is a NMEA/Topline multiplexer which allows the connection of a Topline bus and NMEA 0183 instruments together to a PC and/or a wireless device.

The **USB BOX** features NMEA 0183 V4.1 input port, WiFi and USB connections to receive AIS and/or NMEA 0183 data. It is a communication bridge which converts incoming NMEA data to the **Topline channels** format. Thereafter, they can be used on any **Topline** instrument (displays) connected to the bus.

The **USB BOX** also features NMEA 0183 V1.4, WiFi and USB outputs which concatenate Topline data with NMEA 0183 data collected from the input port to allow interfacing with a PC and/or a wireless device.

The **USB BOX** has a Micro SD-card slot in order to save data.

## 2. NMEA 0183

---

NMEA 0183 is a communication protocol standard defined by the NMEA (www.nmea.org). It allows communication and data sharing between marine electronic devices.

### Examples:

- **USB Box** can send all the navigation data from your instruments system to a PC where navigation software has been installed. The connection can be wired or wireless, via USB or WiFi.
- **USB Box** can receive NMEA0183 data via a wired or wireless connection, USB or WiFi.

### NMEA 0183 sentences

The NMEA 0183 data are defined by readable text sentences. Once the NMEA 0183 output of an instrument is connected to the serial port of a PC and a "terminal" application such as "Tera term" is launched, you will read sentences such as:

```
$IIVHW,263.5,T,265,M,0.00,N,0.00,K*48
```

```
$IIMWD,9.5,T,,M,,N,,M*66
```

```
$IIGLL,4743.5679,N,00320.9843,W,134203,A,D*4E
```

```
$IIRMC,134203,A,4743.5679,N,00320.9843,W,0.0,0,180216,1.5,W,D*16
```

The plain text shown here above is formatted according to the NMEA0183 standard. Every device receiving these sentences must understand that IIGLL means that the data is coming from a navigation instrument (prefix II) and that it contains latitude and longitude (GLL).

## Receiver and Transmitter

The NMEA 0183 standard defines receivers and transmitters. The receivers are devices that receive information and a transmitter sends information to the receiver. Sentences are sent by the transmitter to the receiver when they are connected.

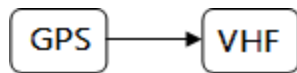

This system shows a GPS sending sentences containing the position to a VHF radio device.

The NMEA 0183 standard specifies that a transmitter must have enough power to be able to communicate with up to four receivers. Usually, we often find two receivers for a transmitter.

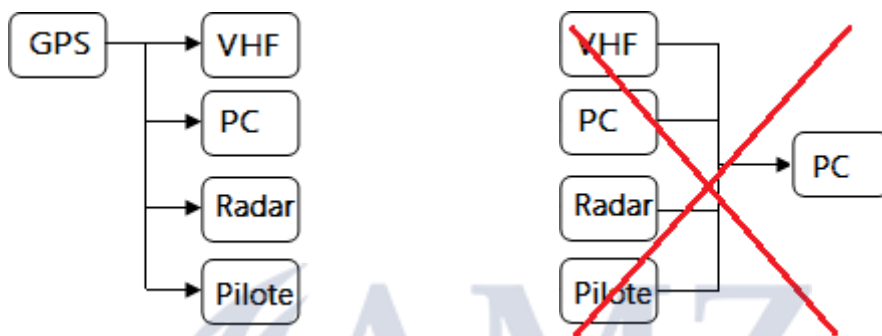

It all becomes complicated when several transmitters have to send information to a receiver, like in this example shown on the right. Unless the receiver features several inputs, a multiplexer is required.

## The multiplexer

A multiplexer features several inputs, each acting as a receiver connected to a transmitter. It also features several outputs able to talk to several receivers. These outputs transmit concatenated data received on the different inputs. The multiplexer listens to each connected device, while stocking all NMEA0183 sentences received and then concatenates the data to send them to one or several receivers. Our USB Box works that way. It can concatenate all data coming from wired and wireless (WiFi, USB) connected devices.

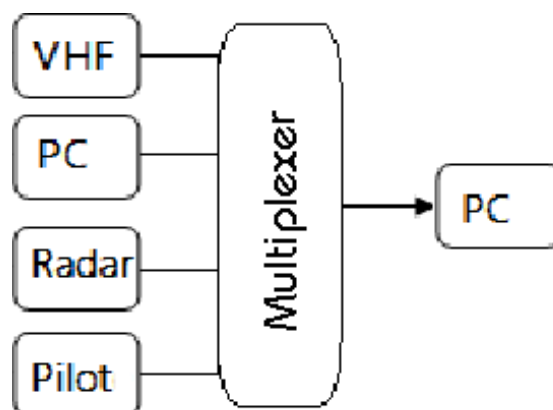

### 3. WIRED NMEA INPUT

---

Connect the two NMEA 0183 input wires (yellow NMEA+ and green NMEA-) to the relevant position on the transmitter (Data out+ and Data out-). For a non-isolated transmitter (only one wire for data), connect the negative supply to the NMEA- of the **USB Box**.

The **USB Box** recognises the flow coming from an AIS or any NMEA0183 device.

The setup procedure of the **USB Box** allows the creation of Topline channels from the NMEA 0183 wired input. An automatic scan of the transmission rate allows reception of AIS 38400 or NMEA 4800, 9600, 19200 and 38400 baud on this input.

The AIS stream received on the wired nmea 0183 input without set up is directly sent to the WiFi connection, the wired NMEA output and USB. **AIS data at 38400 baud is never transmitted to the nke bus.** The reception on a Multigraphic requires a direct connection on the NMEA input of the display. (Refer to the Multigraphic manual)



#### WARNING

Priority is given to the Topline channel: a NMEA 0183 channel is not considered when a similar Topline channel is already on the bus.

When the device connected to the NMEA 0183 input does no longer transmit data, the latest values remain displayed for 55 seconds on the Topline displays.

The wired NMEA 0183 input connection takes priority on the the WiFi and? USB inputs. The WiFi connection takes priority on the USB NMEA input.

List of the channels and associated NMEA 0183 sentences (wired, WiFi, USB connections).

Created channels		NMEA sentences used		
Nr	Label	Priority 1	Priority 2	Priority 3
1	R_SPEEDO	VHW	--	--
2	MAGNETIC HEADING	HDG	VHW	HDM
3	TRUE HEADING	HDT	VHW	--
4	PROF	DPT	DBT	--
5	MINSEC	ZDA	RMC	--
6	LOCHT	VLW	--	--
7	LOCHJ	VLW	--	--
8	HEUJOUR	ZDA	RMC	--
9	TEMP_AIR	MTA	XDR	--
10	TEMP_EAU	MTW	--	--
11	BARO	MMB	XDR	--
12	SPEEDO	VHW	--	--
13	ANEMO	MWV	VWR	--
14	ANG_VENT_APP	MWV	VWR	--
15	DIST_WPT	BWC	RMB	--
16	CAP_WPT (True Heading)	BWC	RMB	--
17	ECART_ROUTE	APB	RMB	XTE
18	V_FOND	VTG	RMC	--
19	CAP_FOND (True)	VTG	RMC	--
20	TEN_ETAIS	XDR	--	--
21	C_WP	APA	APB	--
22	B_PILOT	APA	APB	XTE
23	ANNMOIS	ZDA	RMC	--
24	COMPASS	HDG	VHW	HDM
25	R_ANG_VENT_APP	MWV	VWR	--
26	LAT_DEGMIN	GGA	GLL	RMC
27	LAT_MILMIN	GGA	GLL	RMC
28	LON_DEGMIN	GGA	GLL	RMC
29	LON_MILMIN	GGA	GLL	RMC
30	TENSION_B1	PNKEP,11	--	--
31	COURANT_B1	PNKEP,11	--	--
32	CAPACITE_B1	PNKEP,11	--	--

33	CAPA_PCENT_B1	PNKEP,11	--	--
34	TENSION_B2	PNKEP,12	--	--
35	COURANT_B2	PNKEP,12	--	--
36	CAPACITE_B2	PNKEP,12	--	--
37	CAPA_PCENT_B2	PNKEP,12	--	--
38	V_WP	WCV	--	--
39	VIT_CIBLE	KEP	--	--
40	CAP_OTHER_	KEP	--	--
41	ANGLE_WIND	KEP	--	--
42	REND_PRES	KEP	--	--
43	REND_POLAIRE	KEP	--	--
44	ANGLE_OPT_CMG	KEP	--	--
45	ANGLE_OPT_VMG	KEP	--	--
46	GAIN_ROUTE_CMG	KEP	--	--
47	GAIN_ROUTE_VMG	KEP	--	--
48	DIREC_COURANT	KEP	VDR	--
49	VITES_COURANT	KEP	VDR	--
50	PRESS_ATMOS	MMB	XDR	--
51	DYN1	PNKEA,,1	--	--
52	DYN2	PNKEA,,2	--	--
53	DYN3	PNKEA,,3	--	--
54	DYN4	PNKEA,,4	--	--
55	DYN5	PNKEA,,5	--	--
56	DYN6	PNKEA,,6	--	--
57	DYN7	PNKEA,,7	--	--
58	DYN8	PNKEA,,8	--	--
59	TENSION_B3	PNKEP,13	--	--
60	COURANT_B3	PNKEP,13	--	--
61	CAPACITE_B3	PNKEP,13	--	--
62	CAPA_PCENT_B3	PNKEP,13	--	--
63	TENSION_B4	PNKEP,14	--	--
64	COURANT_B4	PNKEP,14	--	--
65	CAPACITE_B4	PNKEP,14	--	--
66	CAPA_PCENT_B4	PNKEP,14	--	--
67	DECL_MAG	RMC	--	--
68	Waypoint name	RMB and BWC		

## 4. WIRED NMEA OUTPUT

The **nke USB Box** features a wired NMEA0183 output. This NMEA0183 output is not isolated and wired with the red wire and the braid.

The wired NMEA0183 output default setting for data transmission of the Topline bus and data acquired on the NMEA0183 input is 38400 baud.

The NMEA 0183 output data rate can be changed using the Toplink Maintenance Software. Please contact your dealer for more information.

### Wired NMEA 0183 output, WiFi and USB sentences

Channel Topline	XDR	RSA	DBT	DPT	VLW	VHW	MWV	VWR	VWT	MWD	MTW	MMB	HDG	HDM	HDT	VTG	ZDA	GLL	XTE	RMB	RMC	1	2	3	4	5	CUR	WPL	1	2	3	4	ZCD
ANG_INCI	X																																
BARRE		X																															
PROFONDEUR			X	X																													
LOCHJ					X																												
LOCHT					X																												
SPEEDO						X																											
COMPAS						X																											
CAP_VRAI						X																											
GIR_MP							X	X																									
ANG_VENT_APP							X	X																									
ANEMO							X	X																									
ANG_VENT_VRAI							X		X																								
VIT_VENT_VRAI							X		X	X																							
DIR_VENT_VRAI										X																							
TEMP_AIR	X																																
TEMP_EAU											X																						
PRESS_ATMOS												X																					
BARO2												X																					
COMPAS													X	X																			
CAP_VRAI															X																		
CAP_FOND																X						X											
V_FOND																X						X											
ANNMOIS																	X					X											
HEUJOUR																	X	X				X											
MINSEC																	X	X				X											
LAT_DEGMIN																		X				X											
LAT_MILMIN																		X				X											
LON_DEGMIN																		X				X											
LON_MILMIN																		X				X											



Channel Topline	XDR	RSA	DBT	DPT	VLW	VHW	MWV	VWR	VWT	MWD	MTW	MMB	HDG	HDM	HDT	VTG	ZDA	GLL	XTE	RMB	RMC	1	2	3	4	5	CUR	WPL	1	2	3	4	ZCD				
ECART_ROUTE																			X	X																	
D_WP																				X																	
A_WP																				X																	
DECL_MAG																					X																
R_GITE	X																																				
TANGAGE_MES	X																																				
VITESSE_CIBLE																						X															
CAP_OTHER_																							X														
ANGLE_WIND																								X													
REND_PRES																								X													
REN_POLAIRE																								X													
ANGLE_OPT_CM G																									X												
GAIN_ROUTE_C MG																									X												
ANGLE_OPT_VM G																									X												
GAIN_ROUTE_VM G																									X												
DIREC_COURAN T																										X											
VITES_COURANT																										X											
C_COURANT																											X										
V_COURANT																											X										
A_HOMME_MER																												X									
TENSION_B1																													X								
COURANT_B1																													X								
CAPACITE_B1																													X								
CAPA_PCENT_B1																													X								
TENSION_B2																														X							
COURANT_B2																														X							
CAPACITE_B2																														X							
CAPA_PCENT_B2																														X							
TENSION_B3																															X						
COURANT_B3																															X						
CAPACITE_B3																															X						
CAPA_PCENT_B3																															X						
TENSION_B4																																X					
COURANT_B4																																X					
CAPACITE_B4																																X					
CAPA_PCENT_B4																																X					
CHRONO																																				X	

## 5. WIFI CONNECTION

---

With its WiFi interface, the **nke USB Box** can communicate with wireless devices such as smartphones, tablets, and computers (PC or Mac). The **nke display Pro** app is available for Android and iOS smartphones and tablets (refer to the Application chapter: **nke display pro §14**)

The **nke USB box** acts as a multiplexer and transmits on the WiFi line:

- AIS or NMEA 0183 sentences coming from the NMEA 0183 inputs.
- Data from the Topline bus, converted to the NMEA 0183 format.

The **nke USB box** receives the NMEA data from external app via WiFi and publishes new channels on the bus once it has been set up (i.e.: Bearing and Distance to Waypoint...)

The **nke USB box** provides a wireless access point via its interface 802.11b+g and with the following parameters:

- SSID: nke-xxxxx
- WPA: 21xxxxxxxxxxx (serial number of the **nke USB box** located on the label).
- IP address: 192.168.56.1
- Port: 50000
- TCP + UDP Protocols
- DHCP server activated

TCP is a communication protocol limiting the connection to one single device.

**UDP** allows the communication with several connected devices simultaneously.

An integrated DHCP server automatically assigns IP addresses to the devices which are wireless connecting to the **nke USB box**. Therefore, it is not necessary to change the Network setup of your wireless device. The **nke USB box** can bear the connection of 7 devices simultaneously.

The NMEA 0183 transmitted data are the same as those transmitted via the wired output (refer to the table "NMEA0183 sentences on wired connection, WiFi and USB" §4).

## 6. USB CONNECTION

---

The *USB* connection transmits AIS data and NMEA 0183 sentences coming from the inputs NMEA 0183 inputs together with the Topline Bus data, converted to the NMEA format. It can also send the NMEA0183 data to the Topline Bus after initialisation (if the relevant Topline channels are available (i.e.: bearing and distance to Waypoint...)).

The NMEA 0183 transmitted data are the same as those transmitted via the wired output (refer to the table "NMEA0183 sentences on wired connection, WiFi and USB" §4).

The *USB* connection simulates a serial port link at 115200 Baud.

This USB connection is also used as a bridge for the Toplink maintenance software.



## 7. DATALOG

The **nke USB box** features an integrated stand-alone NMEA data-logger with microSD-Card. This data-logger can save in a text file all NMEA and AIS data received by the **nke USB box**. The default setting is made to save data transmitted on the wired input.

A new file NKExxxx.LOG is created at each start of the Box. Optionally, a timestamp can be inserted at the line start, giving a time reference to the NMEA recorded data.

A LED indicator, labelled SD-CARD, gives the status of the logger.

Green flash: saving data

Red flash: reading or writing fault on the SD-CARD

Red fix: the card is full or faulty, or the file format is not supported (FAT32 only)

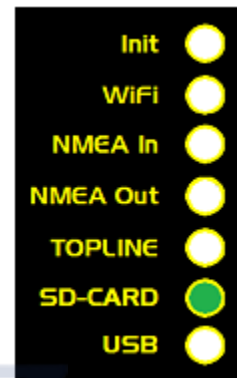

### Characteristics:

- Compatible cards: microSD (<2go) microSDHC (4 to 32go)
- File system: FAT32 only
- Formatting: SDFormatter V4.0 or by pressing the Init button of the Box for 24 seconds (24 beeps).

### Operating applications

ScanNav

Adrena

Expedition

```
==> Box WiFi V2.0 Start logging
$PNKEV,Box WiFi nke,V2.0,Apr 3 2015,20:08:11,00.06.66.6B.E9.0E,v4.41*78
$IIXDR,U,12.609,V,BatWiFi*19
$IIVTG,,T,,M,0.2,N,0.3,K,A*35
$IIGLL,4743.2976,N,00359.7002,W,101012,A,A*45
$IIRMC,101012,A,4743.2976,N,00359.7002,W,,190815,,,A*5A
$IIXDR,A,-3.4,D,ROLL,A,3.0,D,PTCH*75
$IIVHW,,T,205,M,0.00,N,0.00,K*62
$IHDG,205,,,*50
$IHDG,205,M*3B
$IIRSA,4.0,A,,V*7D
$IIMWD,,T,212,M,7.0,N,3.6,M*77
$IIMTW,12.3,C*13
$IIXDR,A,-3.2,D,ROLL,A,3.0,D,PTCH*73
$IIRSA,3.3,A,,V*79
$IIMWV,9,R,7.0,N,A*2D
$IIVWR,9,R,7.0,N,3.6,M,13.0,K*6E
$IIXDR,A,-2.8,D,ROLL,A,3.0,D,PTCH*78
$IIZDA,101013,19,08,2015,,*5B
$IIMMB,30.1102,1,1.01953,B*47
$IIVWT,9,R,7.0,N,3.6,M,13.0,K*68
```

**Extrait d'un fichier NKExxxx.LOG**

## 8.

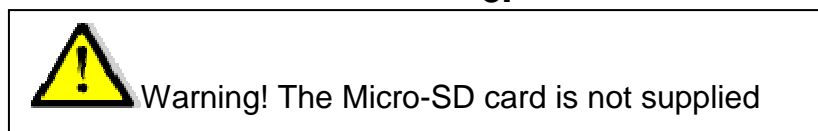

## 8. SETUP WITH A MULTIGRAPHIC

If your **nke USB box** is connected to a Topline Bus system including a Multigraphic (V2.0 or >), you can change the SSID and the WiFi channel.

Changing the SSID from the Multigraphic:

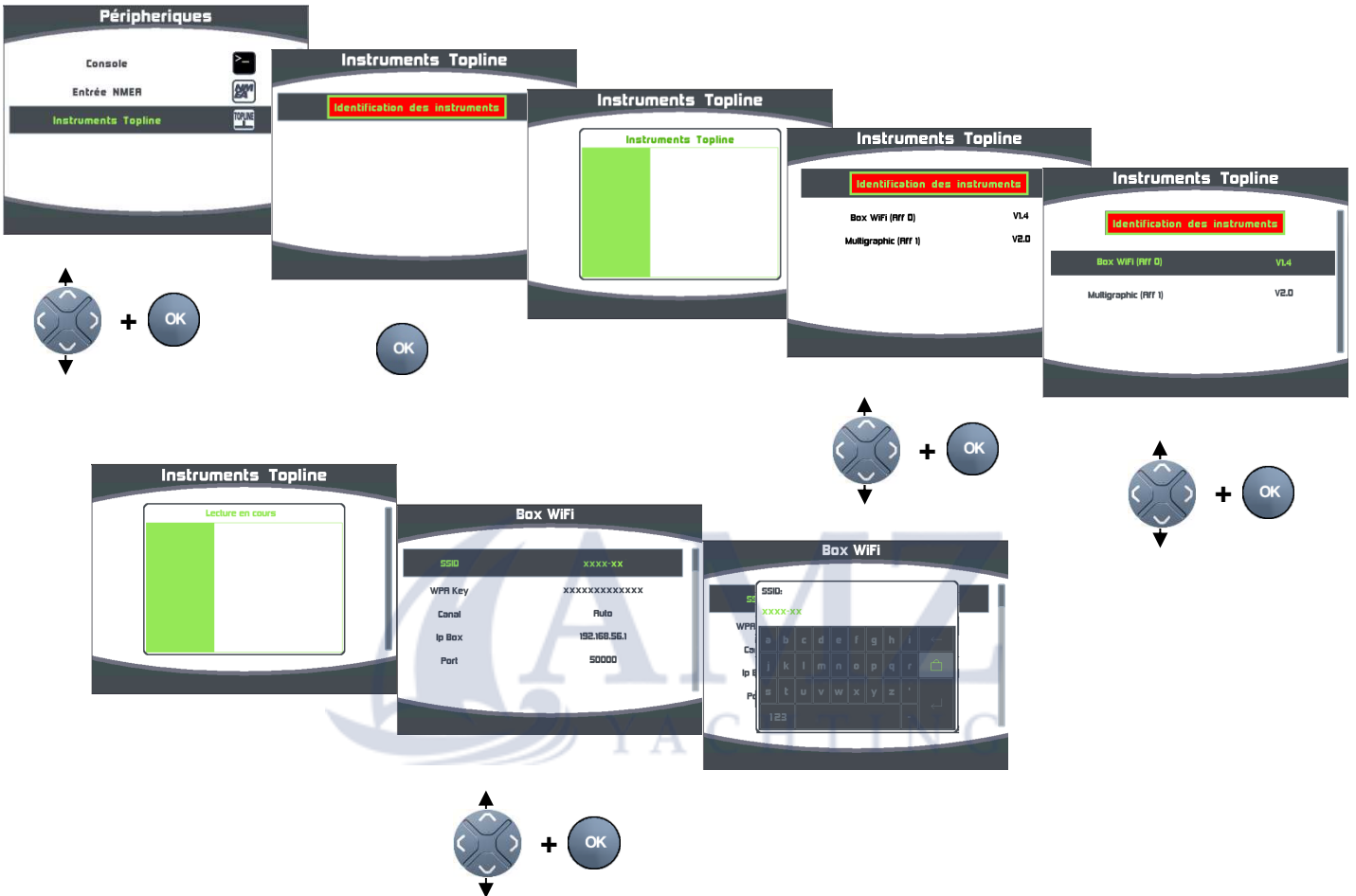

Changing the WIFI channel from the Multigraphic.

You can choose between "Automatic" and 13 channels. The default setting is "Automatic".

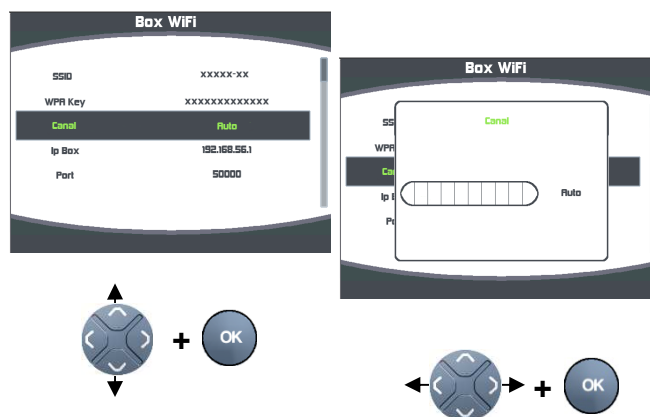

## 9. INDICATORS

---

There are 7 indicators for the operating status of the *nke USB box*

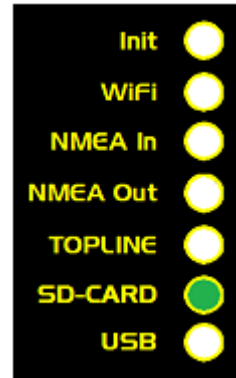

Init	<ul style="list-style-type: none"> <li>●</li> <li>●</li> </ul>	<p>Press the Init button</p> <p>Acknowledgment with an audible beep</p>
Wi-Fi	<ul style="list-style-type: none"> <li>●</li> <li>●</li> </ul>	<p>Wi-Fi sending</p> <p>Wi-Fi receiving</p>
NMEA In	<ul style="list-style-type: none"> <li>●</li> <li>●</li> <li>●</li> </ul>	<p>Off, no data on the wired NMEA input</p> <p>Flashes at each incoming valid NMEA sentence on the NMEA wired input</p> <p>Flashes at each incoming invalid NMEA sentence on the NMEA wired input</p>
NMEA Out	<ul style="list-style-type: none"> <li>●</li> </ul>	<p>Flashes at each NMEA sentence sent on the NMEA wired output</p>
TOPLINE	<ul style="list-style-type: none"> <li>●</li> <li>●</li> <li>●</li> <li>●</li> </ul>	<p>Quick flash if the Box has a Topline address</p> <p>Quick flash if the Topline address = 0</p> <p>Fix, the Topline Bus data wire is unplugged or "No Master"</p> <p>1 blip per second, interface is given the address 0 and Bus data wire is unplugged or "No Master"</p>
SD-CARD	<ul style="list-style-type: none"> <li>●</li> <li>●</li> <li>●</li> </ul>	<p>Quick flash for data saving</p> <p>Quick flash for reading or writing data fault</p> <p>Fix, the card is full or faulty, or the file format is not supported (FAT32 only)</p>
USB	<ul style="list-style-type: none"> <li>●</li> <li>●</li> </ul>	<p>Quick flash NMEA sentence sending</p> <p>Flashes at each incoming invalid NMEA sentence on the USB input</p>

## 10. USE OF THE "INIT" BUTTON

---

- Press and hold 1 second, Displays the number of devices connected to the Box via WIFI. It is possible to connect up to 7 devices simultaneously, but only 5 will be affected to the LED indicators on the Box.
  - 1 device = Topline led turns red
  - 2 devices = Topline led + NMEA Out turn red
  - 3 devices = Topline led + NMEA Out + NMEA In turn red
  - 4 devices = Topline led + NMEA Out + NMEA In + WIFI turn red
  - 5 devices = Topline led + NMEA Out + NMEA In + WiFi + Init turn red
- Press and hold 3 seconds, followed by "ON/OFF" for resetting the NMEA input interface (wired, WiFi and USB) and the Topline address.
- Press and hold 3 seconds for initialisation of the NMEA Input (wired, WIFI and USB), read the NMEA sentences for 10 seconds and then creation of a list with Topline address (**slave only**). At the end of the sequence, a series of beeps is sent according to the number of channels created on the Topline Bus.
- Press and hold 6 seconds for a second NMEA initialisation, adding NMEA channels without deleting the existing table. This function allows for example to add NMEA channels originated from the WIFI input without deleting the configuration of the wired NMEA Input.
- Press and hold 9 seconds for factory reset of the WIFI module.
- Press and hold 10 seconds for the initialisation of the NMEA Inputs (wired, WIFI and USB), listening the NMEA sentences for 10 seconds and then creation of a list with **Topline address as Master**, if available on the bus. At the end of each sequence, you will hear a series of beeps according to the number of channels created on the Topline Bus.
- Press and hold 20 seconds to format the Micro SD card.
- Press and hold 27 seconds for ON/OFF of the WIFI.

### Initialisation of the *NMEA Input*



#### **WARNING**

The NMEA data coming from an AIS receiver do not require an initialisation of the NMEA Input, they are directly transmitted by the NMEA outputs (wired, Wi-Fi and USB).

The AIS data do not go through the Topline Bus. To display AIS targets on a Multigraphic, the AIS data must come to the Multigraphic's NMEA Input.

The **NMEA Input** must be set up to recognise and memorize the NMEA sentences transmitted by the connected device (GPS, PC, etc.). The NMEA channels which have been created are saved in the **nke USB Box's** memory and restored on the Topline Bus at each start of the system.

### Initialisation procedure

- Make sure that the NMEA 183 source is correctly transmitting the data, and then, press **INIT** and hold until you hear 3 beeps.
- The NMEA input will then scan the NMEA0183 data and you can hear the series of beeps during ten seconds ending with a longer beep to notify the end of that search sequence.
- Then, you will hear a series of beeps according to the number of channels created on the Topline Bus.



#### WARNING

If there is no data coming on the NMEA 183 Input, this procedure leads to allocate a "Slave" address to the **nke USB Box**. In that case, the **nke USB Box** is recognised by the "Master" display as a "Slave" device.



## 11. INSTALLATION

---

### List of the accessories

- Mini USB / USB cable

### Installation precautions

The protection rate of the **nke USB Box's** housing is IP54. Therefore, it cannot be immersed, even for a short period. Make sure you set this up somewhere that will not be immersed.

### Mounting the housing of the **nke USB Box**

- Fix the housing with  $\varnothing 4\text{mm}$  screws

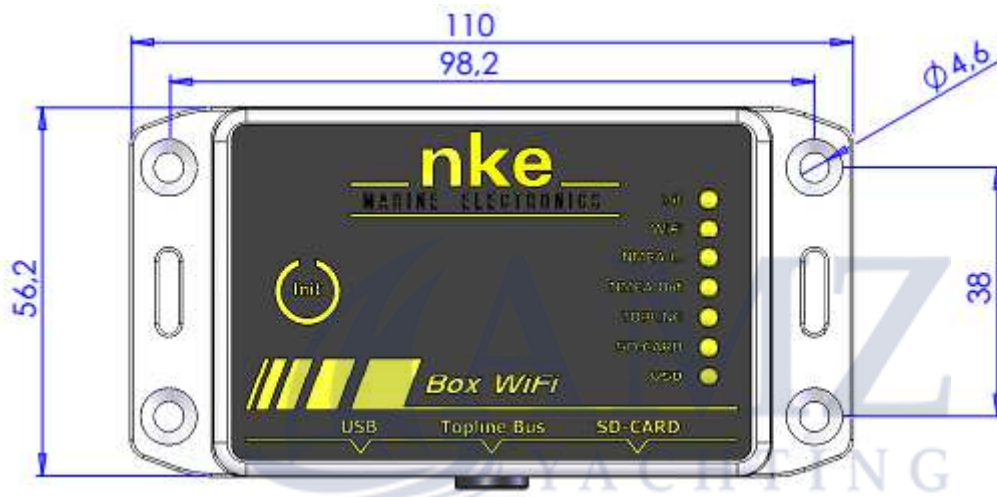

### WARNING:

- The **nke USB Box** must be **not powered** when you work on the connections wiring

### Connection to the Topline bus

1. Run the bus cable from **nke USB Box** to a **TOPLINE** junction on your system.
2. Wire the Bus connection.
3. NMEA+ and NMEA- are connected to the NMEA 183 source device or to an AIS receiver.

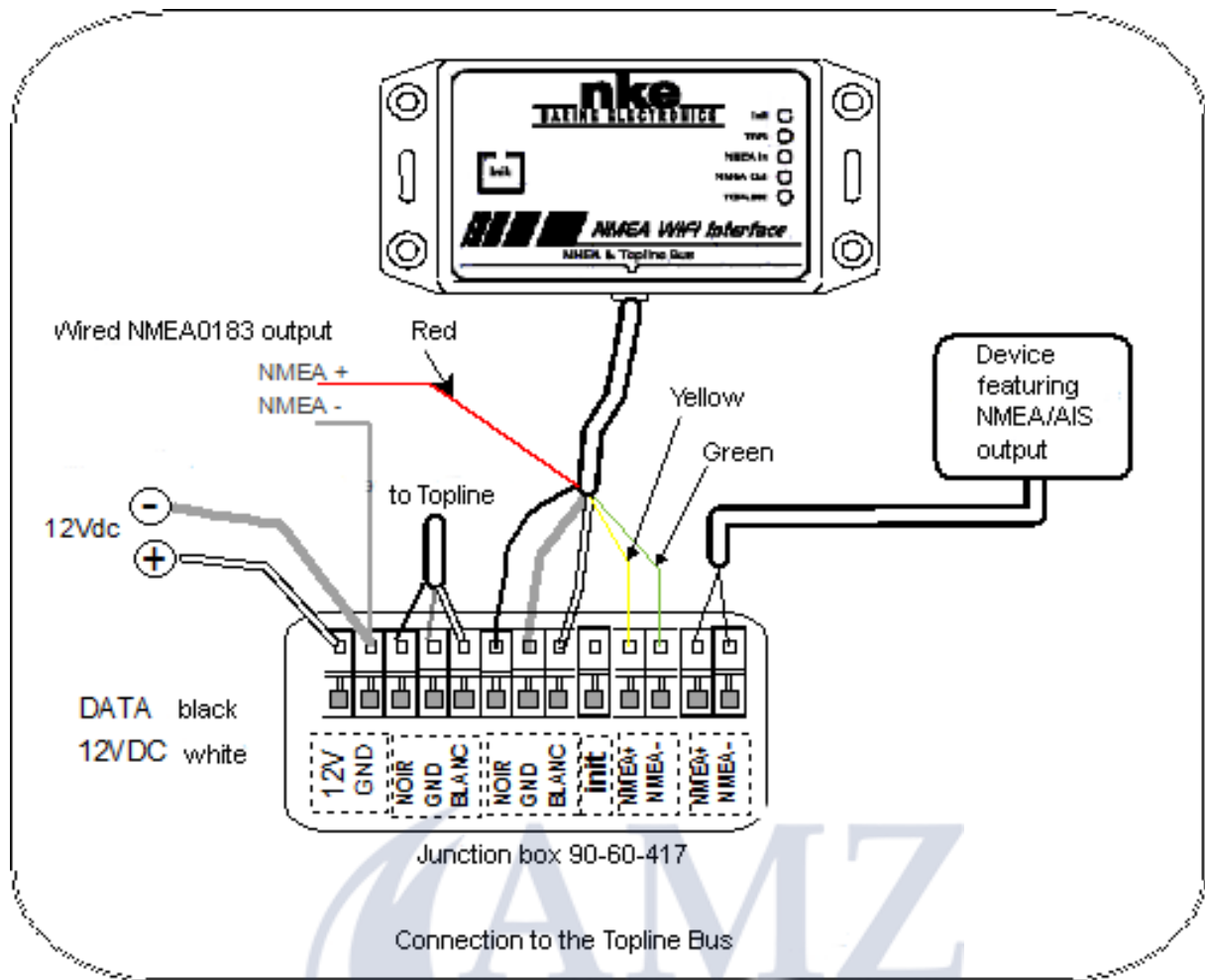

Should you shorten the Bus cable length, strip off and tin the wires before connecting them in the junction box.

### Wires colour code

White cable, 5 wires	Colour code	
White	+12V	<b>TOPLINE</b> Bus
Black	<i>Topline</i> Data	
Shield	Common	
Red	NMEA output	
Yellow	NMEA +	NMEA input
Green	NMEA -	

## Interfacing examples for the *nke USB Box*

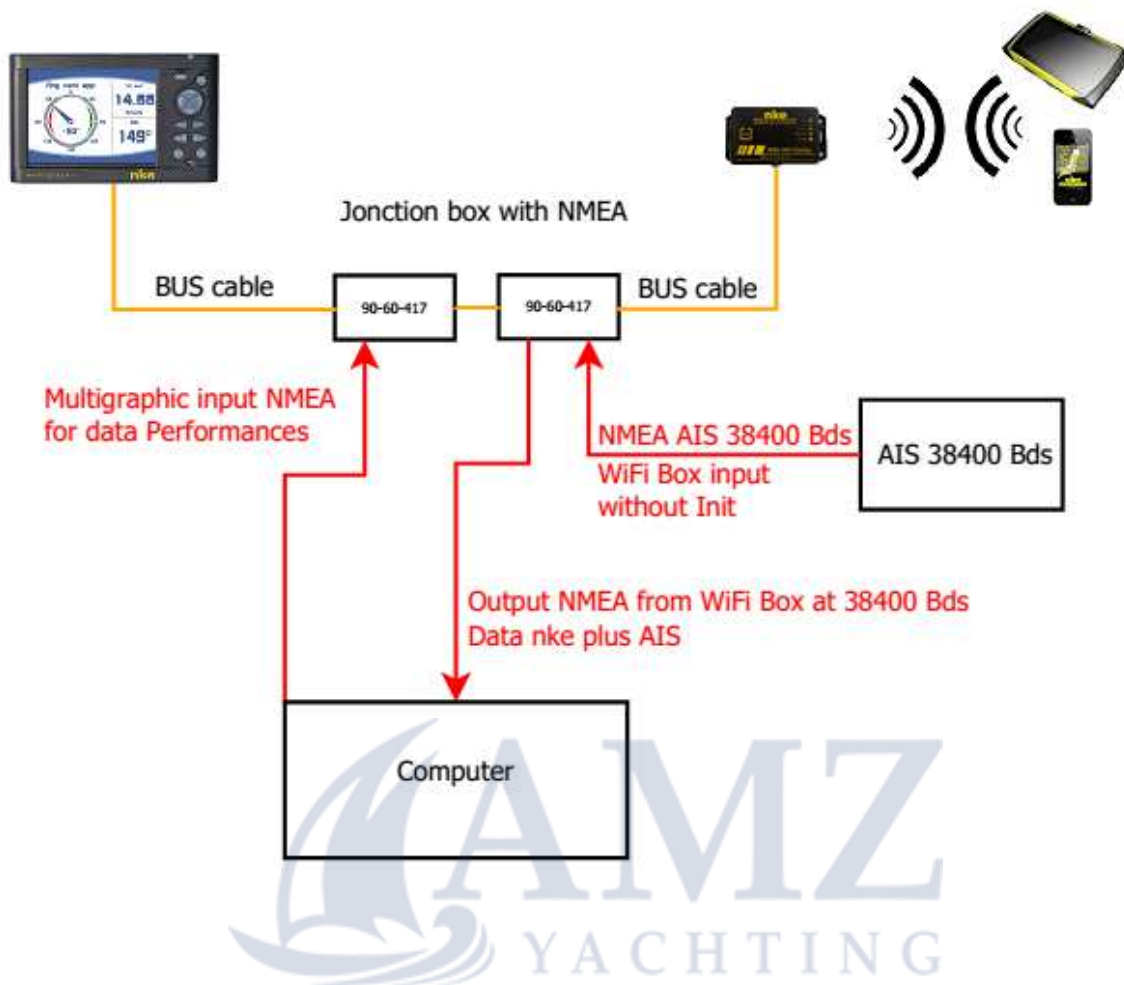

In this first example, the AIS is directly linked to the USB Box NMEA 0183 Input. AIS and the Bus data are retransmitted by the USB Box via the wired, WIFI and USB connections.

Two situations are possible:

- There is already a GPS in the Toplevel System. You can run an initialisation for 3 seconds to allocate an address to the USB Box. The Toplevel channels already existing on the bus will not be created.
- There is no GPS in the Toplevel System. You can run an initialisation for 3 seconds with the AIS powered on. This operation has to be done in two steps in order to create the COG sentence.

In the drawing here above, the performance data are not transmitted by the PC to the Multigraphic's NMEA0183 Input. To have them available on the Bus, that Input also must be initialised.

In this second example, the AIS is directly linked to the USB Box's and the Multigraphic's NMEA0183 Inputs. AIS and the Bus data are retransmitted by the USB Box via the wired, WIFI and USB connections.

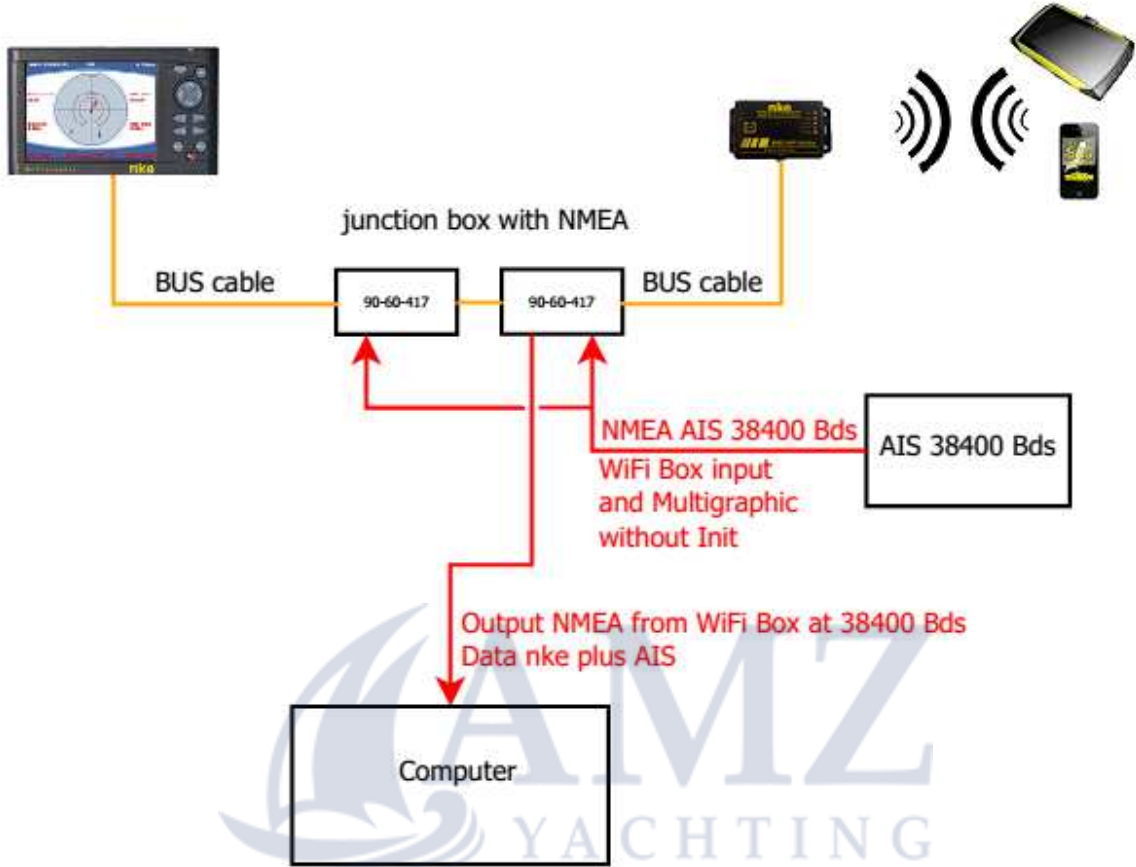

## 12. FLOW CHART

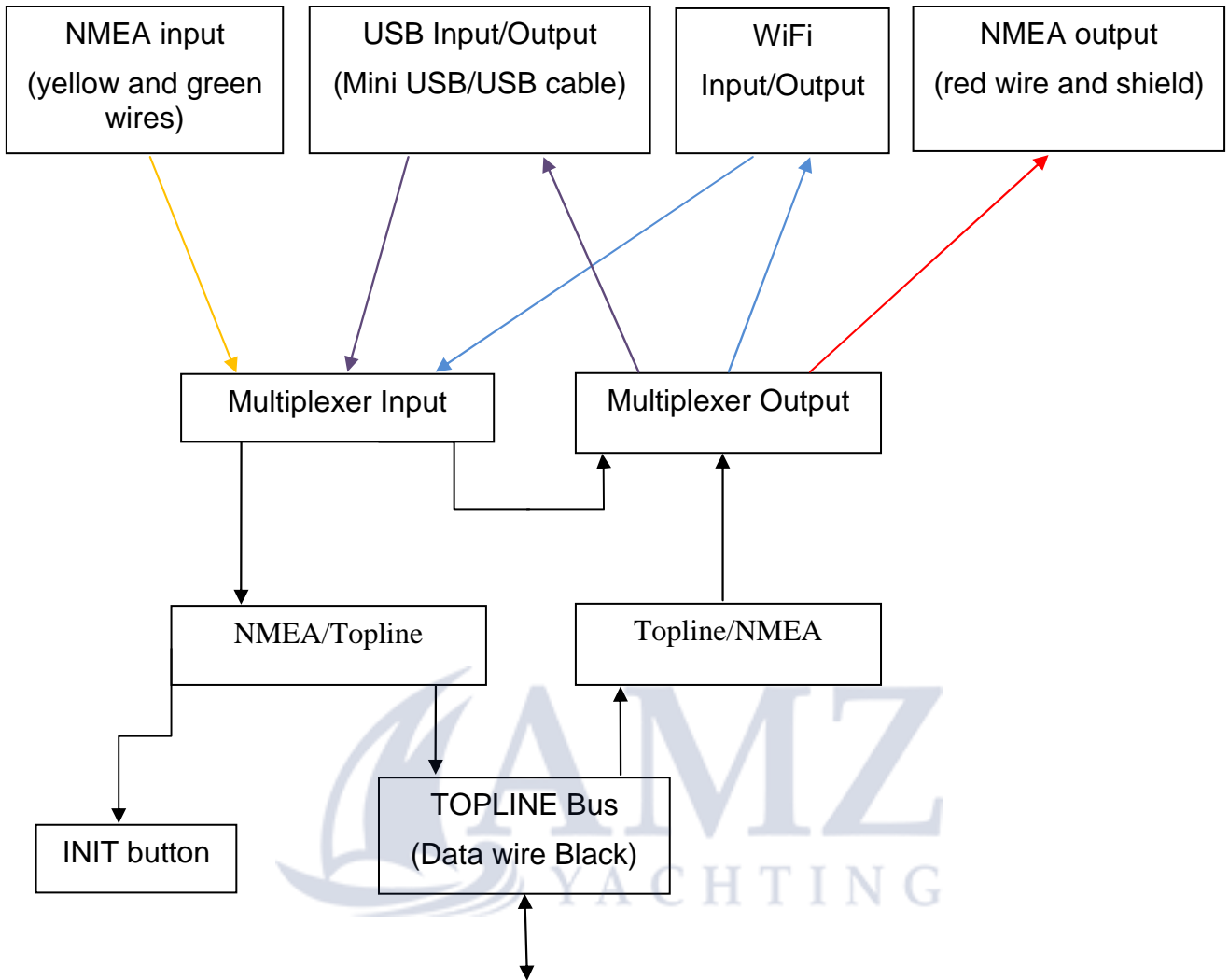

### 13. SET A WIFI CONNECTION WITH A SMARTPHONE

Connect the device to the Wi-Fi of the **nke USB Box** to be able to use the data coming from you Topline system on board.

Activate your smartphone's Wi-Fi function:



Select the **nke USB Box** WIFI (see the SSID on the **USB Box** label) in the list of detected networks.

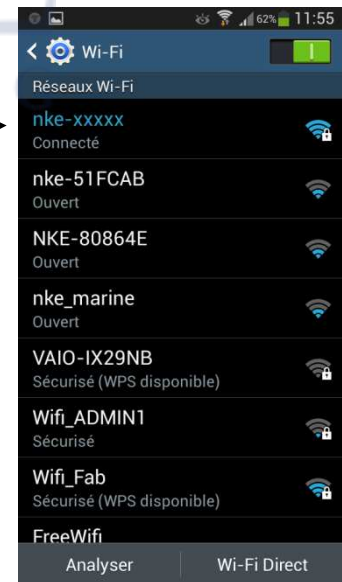

Enter the password (WPA on the label of the **USB Box**) and press "Connect".



Configure the software application (here, nke Display) you wish to use with the **USB Box** with the following IP address for the **USB Box** : 192.168.56.1, the Port "50000" and the protocol "UDP or TCP".



### WARNING

If your device uses a firewall, check that "**Port 50000**" is available.

## 14. THE APPLICATION "NKE DISPLAY PRO"

**nke Display Pro** is an application available for Android and iOS smartphones and tablets.

With it, you can retrieve all the Topline Bus data and display them on your smartphone or tablet. Two options can be purchased: The Multifunction Control and the Autopilot Control.

Examples of pages available on a smartphone or tablet



Autopilot Control (optional)

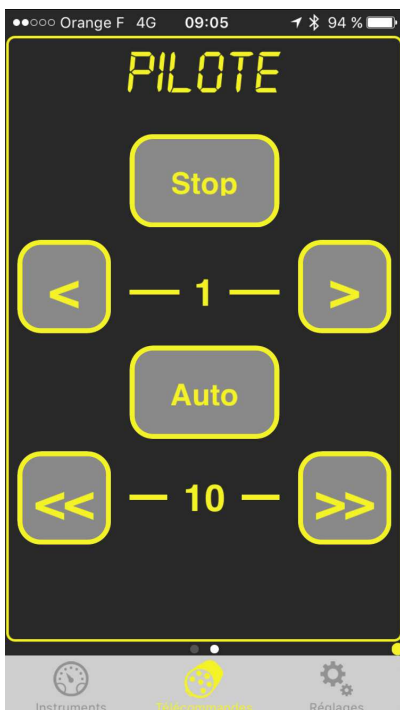

Multifunction Control (optional)

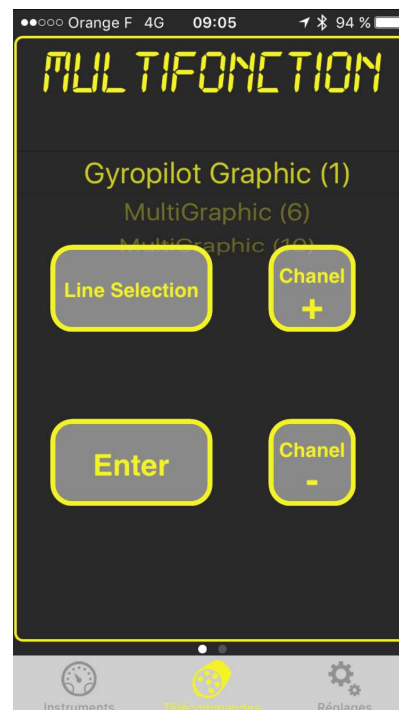



## 15. TECHNICAL SPECIFICATIONS

---

Settings	Values
Dimensions	110x56,4x26mm (length x height x depth)
Weight	200g with 3m of cable (32g/m)
Power supply	8V – 32V DC
Consumption @ 12 volts	50 mA
NMEA input	NMEA 0183, @ 4800 to 38400 automatically set Reading AIS data without NMEA input initialisation
Wired NMEA output	NMEA 183 @ 38400 and settable with Toplevel software at: 4800, 9600, 19200,57600 Baud
Input/Output NMEA USB	NMEA 183 @ 115200 bauds.
WiFi Connection	WiFi 802.11b+g SSID: NKE-xxxxxx IP address: 192.168.56.1 Port: 50000 Protocol: TCP + UDP Lighting distance EN ~ 35m
Micro SD-CARD slot	Compatible cards: - microSD (<2go) - microSDHC (4 to 32go)
Technical / Environmental	Waterproof IP54 (protected against dust and water projections) Storage temperature: -20°C to +60°C Operational temperature: -10°C to +50°C
Power cable	Ø5,5 mm, 4 wires + ground wire, length 3 m.

# Déclaration de conformité

Nous,

Nke marine electronics  
rue Gutenberg  
ZI de Kerandré  
56700 HENNEBONT  
Tel : +33 297 365 685  
Fax ; +33 297 364 674

Hereby, NKE Electronics declares under their responsibility, that this:

BOX WIFI

Is in compliance with the following specification requirements:

Déclarons sous notre seule responsabilité que le produit

BOX WiFi

Auquel se réfère cette déclaration est en conformité avec les spécifications suivantes :

Safety : EN 60950-1 :2006+A11 :2009+A1 :2010  
Health: EN 50371 :2002-03  
EMC : EN 301 489-1 V1.8.1 :2008-04, EN 301 489-17 V2.1.1 :2009-05  
Radio : EN 300 328 V1.7.1 :2006-10  
FCC Part 15C, FCC id : T9J-RN171  
IC : RSS-210

Le produit est conforme aux exigences de la directive CEM 89/336/CEE et porte en conséquence le marquage CE.

Hennebont

Jean Claude LE BLEIS



Cet appareil est conforme à la partie 15 des règles de la FCC. Son fonctionnement est soumis aux conditions suivantes : (1) ce dispositif ne peut pas causer d'interférences nuisibles, et (2) cet appareil doit accepter toute interférence reçue, y compris les interférences qui peuvent provoquer un fonctionnement indésirable.

**CE0681** **FC**

This product is in compliance with the CEM 89/336/CEE Directive and therefore, it is marked CE.